

Escutcheons

	Page	No
	Escutcheon Ø50 x 2 mm, solid c-c 30 mm, machine screws . . . 62	1100
	Escutcheon Ø50 x 2 mm, solid c-c 38 mm, machine screws . . . 66	1116
	Escutcheon Ø50 x 2 mm, solid c-c 38 mm, wood screws 65	1115
	Rose cover Ø52 x 4 mm, c-c 30 mm, machine screws 68	1140
	Flip-up handle, solution for elderly and disabled people 69	1140.038
	Rose cover Ø52 x 4 mm, c-c 38 mm, wood screws 70	1145
	Rose cover Ø52 x 4 mm, c-c 38 mm, machine screws 71	1146
	Tapered cylinder rings:	
	For ASSA-cylinder, inner. 63	1100.x8.Axi
	For ASSA-cylinder, outer 63	1100.x8.Axu
	For Rokoko-cylinder, inner. 64	1100.08.ARx
	Escutcheon 65 x 30 x 3 mm, solid c-c 49 mm 72-73	1190
	Escutcheon 65 x 30 x 4 mm, rose cover, c-c 49 mm 74-75	1194
	Emergency fitting for turnknob, Ø55 mm, inside Ø50 mm. . . 64	1109
Escutcheons for Randi-Line® Square, design Friis & Moltke		
	Escutcheon, 50 x 50 x 2 mm, c-c 30 mm, machine screws . . . 76	1110
	Escutcheon, 50 x 50 x 2 mm, c-c 38 mm, machine screws . . . 78	1126
	Escutcheon, 50 x 50 x 2 mm, c-c 38 mm, wood screws 77	1125
	Lever rose, rectangular, 50 x 150 x 2 mm, c-c 30 mm, machine screws 79	1112
		
	Lever rose, rectangular, 50 x 150 x 2 mm, c-c 38 mm, wood screws 80	1127
		
	Lever rose, rectangular, 50 x 150 x 2 mm, c-c 38 mm, machine screws 80	1128
		

no 1100



Escutcheons, solid, $\varnothing 50 \times 2$ mm.

Available in satin stainless steel (AISI 304) or bright polished brass.

With threaded bushes attached, fixing centres 30 mm, screws visible on one side.

Supplied in pairs including machine screws M4x84 mm.

Bathroom escutcheons: Standard for door thickness 34–50 mm.

Fits Scandinavian standard locks.

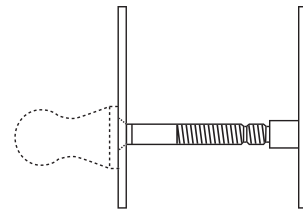

• 25 •

Product variants:



Cyl/turn
1100.x1.A



Cyl/turn
1100.x1.Ax



Cyl/turn
1100.014.A



Turn
1100.x1.AM4



Cyl/cyl
1100.x2.A



Cyl/cyl
1100.x2.Ax



Bathroom
1100.x3.TA/TG



Bathroom
1100.034.TA/TG



Bathroom
1100.x36.TA/TG
1100.x36.TA/TG-SK (to a sliding door lock)



Keyhole
1100.x4.M



Blind
1100.x5



Cyl/turn
1100.x16.A

Stainless steel: x = 0 Brass: x = 9

Cyl/turn set available with cylinder rings in various heights. Stainless steel: 7, 11, 13, 16, 18, 20 mm. Brass: 6, 8, 11, 13, 16, 18, 21 mm.

no 1100.x8



Tapered cylinder rings, inner or outer, ø53 mm.

Available in satin stainless steel or bright polished brass, in various heights.

Drilled for M4 screws, fixin centres 30 mm, supplied singly.

Inside rings supplied incl. machine screws M4x84 mm.

Fits Scandinavian standard locks.

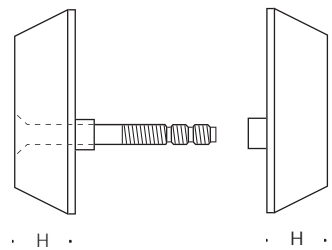

Stainless steel height mm (H)	Inner	Outer
7	1100.08.A7.i	1100.08.A7.u
11	1100.08.A11.i	1100.08.A11.u
13	1100.08.A13.i	1100.08.A13.u
16	1100.08.A16.i	1100.08.A16.u
18	1100.08.A18.i	1100.08.A18.u
20	1100.08.A20.i	1100.08.A20.u

Polished brass height mm (H)	Inner	Outer
6	p1100.98.A6.i	p1100.98.A6.u
8	p1100.98.A8.i	p1100.98.A8.u
11	p1100.98.A11.i	p1100.98.A11.u
13	p1100.98.A13.i	p1100.98.A13.u
16	p1100.98.A16.i	p1100.98.A16.u
18	p1100.98.A18.i	p1100.98.A18.u
21	p1100.98.A21.i	p1100.98.A21.u

no 1100.08.AR.x



Tapered cylinder ring (inner), \varnothing 53 mm.

Available in satin stainless steel (AISI 304).

Drilled for M4 screws, fixing centres 30 mm.

Supplied singly including M4x84 mm screws.

Stainless steel Heights mm (H)	Inner
7	1100.08.AR.7
11	1100.08.AR.11
13	1100.08.AR.13
16	1100.08.AR.16
18	1100.08.AR.18
20	1100.08.AR.20

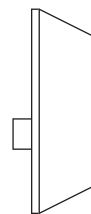

· H ·

Fits Scandinavian standard locks.

no 1109.00



Emergency fitting for Randi turnknob, \varnothing 55 mm, fits Randi turnknob no 1100.01. AM4, page 62.

Stainless steel ring, inside \varnothing 50 mm.

Supplied with detachable plastic cover.

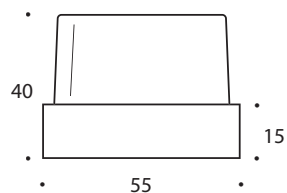

no 1115



Escutcheons, solid, $\varnothing 50 \times 2$ mm.

Available in satin stainless steel (AISI 304) or bright polished brass.

Drilled for wood screws, fixing centres 38 mm.

Supplied in pairs including wood screws 3,5x13 mm.

Bathroom escutcheons: Standard for door thickness 34-50 mm.

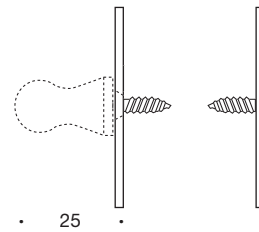

Product variants:



Latch
1115.x0



Cyl/cyl
1115.x2.R



Keyhole
1115.x4.B



Cyl/turn
1115.x1.R



Bathroom
1115.x3.TG/TE



Keyhole
1115.x4.M



Cyl/cyl
1115.x2.E



Bathroom
1115.034.TG/TE



Blind
1115.x5



Cyl/cyl
1115.x2.K



Bathroom
1115.x36.TG/TE

Stainless steel: x = 0 Brass: x = 9

no 1116



Escutcheons, solid, $\varnothing 50 \times 2$ mm.

Available in satin stainless steel (AISI 304) or bright polished brass.

With threaded bushes attached, fixing centres 38 mm, screws visible on one side.

Supplied in pairs including machine screws M4x84 mm and Randi-Plug®.

Bathroom escutcheons: Standard for door thickness 34-50 mm.

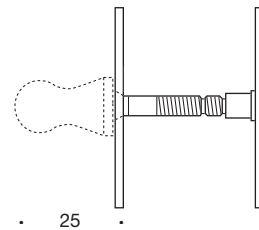

• 25 •

Product variants:



Latch
1116.x0



Bathroom
1116.034.TG



Blind
1116.x5



Cyl/cyl
1116.x2.E



Cyl/cyl
1116.02.ES



Bathroom
1116.x36.TG



Cyl/cyl
1116.x2.K



Keyhole
1116.x4.B



Bathroom
1116.x3.TG



Keyhole
1116.x4.M

Stainless steel: x = 0 Brass: x = 9

1116.02.ES available with stainless steel cylinder rings in various heights: 8, 10, 12, 14, 16 mm. Ex. how to order: 1116.02.ES10.



no 1140



Escutcheons, $\varnothing 52 \times 4$ mm.

Available in satin stainless steel (AISI 304) or bright polished brass.

Fixing centres 30 mm, no visible screws.

Supplied in pairs including machine screws M4x84 mm and threaded bushes.

Bathroom escutcheons: Standard for door thickness 34-45 mm.

Fits Scandinavian standard locks.

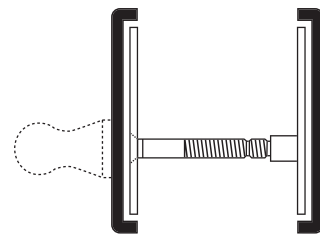

• 27 •

Product variants:



Latch
1140.x0



Cyl/turn
1140.x1.A



Turn
1140.x1.AM4



Cyl/turn
1140.014.A



Cyl/turn
1140.x16.A



Cyl/cyl
1140.x2.A



Bathroom
1140.x3.TA/TG



Bathroom
1140.034.TA/TG



Bathroom
1140.x36.TA/TG
1140.x36.TA/TG-SK (to a sliding door lock)



Keyhole
1140.x4.M



Blind
1140.x5

Stainless steel: x = 0 Brass: x = 9

Cyl/turn set available with cylinder rings in various heights. Stainless steel: 7, 11, 13, 16, 18, 20 mm. Brass: 6, 8, 11, 13, 16, 18, 21 mm.

no 1140.038

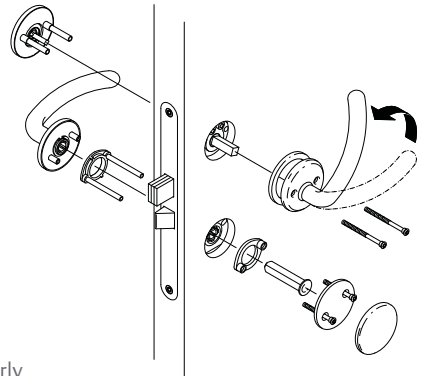

The Flip-Up handle is a special design for use by the handicapped and elderly, making it easy to use the door and lock/unlock, simply by pulling the handle up or pushing it down. This means that the user avoids having to use the twisting action common to many locks, and which is often difficult for these two user groups.

Its simple use makes the Flip-Up handle ideal for all forms of buildings where ease of use by the handicapped and elderly is required, particularly hospitals, care homes, sheltered homes etc.

Available in satin stainless steel (AISI 304).

Supplied with special „turn“ on the inside, lever handle on the outside (style 1011, 1021, 1060, or 1090) and matching escutcheons ø52x4 mm, M4 machine screws and Randi-plug. Fixing centres 30 mm. Standard door thickness 40 mm.

Fits Scandinavian standard locks.

Product variants:



Style 1011
11.40.038/1011



Style 1060
11.40.038/1060



Style 1021
11.40.038/1021



Style 1090
11.40.038/1090

no 1145



Escutcheons, $\varnothing 52 \times 4$ mm.

Available in satin stainless steel (AISI 304) or bright polished brass.

Drilled for wood screws, fixing centres 38 mm, no visible screws.

Supplied in pairs including stainless steel wood screws 3,5x13 mm.

Bathroom escutcheons: Standard for door thickness 34-45 mm

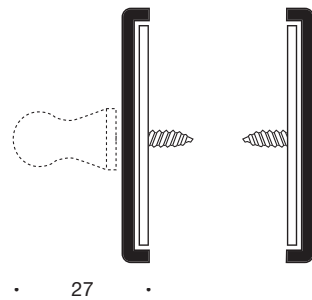

Product variants:



Latch
1145.x0



Bathroom
1145.034.TG



Blind
1145.x5



Cyl/cyl
1145.x2.E



Bathroom
1145.x36.TG



Cyl/cyl
1145.x2.K



Keyhole
1145.x4.B



Bathroom
1145.x3.TG



Keyhole
1145.x4.M

Stainless steel: x = 0 Brass: x = 9

no 1146



Escutcheons, $\varnothing 52 \times 4$ mm.

Available in satin stainless steel (AISI 304) or bright polished brass.

Fixing centres 38 mm, no visible screws.

Supplied in pairs including machine screws M4x84 mm, threaded bushes and Randi-Plug®.

Bathroom escutcheons: Standard for door thickness 34-45 mm.

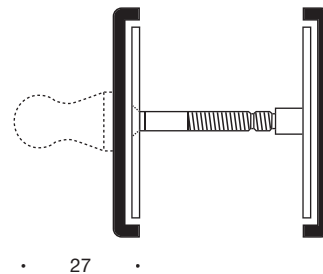

Product variants:



Latch
1146.x0



Bathroom
1146.034.TG



Blind
1146.x5



Cyl/cyl
1146.x2.E



Cyl/cyl
1146.02.ES



Bathroom
1146.x36.TG



Cyl/cyl
1146.x2.K



Keyhole
1146.x4.B



Bathroom
1146.x3.TG



Keyhole
1146.x4.M

Stainless steel: x = 0 Brass: x = 9

1146.02.ES available with stainless steel cylinder rings in various heights: 8, 10, 12, 14, 16 mm. Ex. how to order: 1146.02.ES10.

no 1190



Oval escutcheons, 65x30x3 mm, for narrow profile doors.

Available in satin stainless steel (AISI 304) or bright polished brass.

Drilled for wood screws, fixing centres 49 mm.

Supplied in pairs including wood screws 4x16 mm and machine screws M4x16 mm.

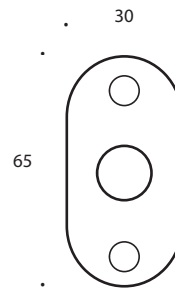

Product variants:



Latch
1190.x0



Cyl/cyl
1190.x2.K



Cyl/turn
1190.x1.A



Keyhole
1190.x4.B



Cyl/cyl
1190.x2.A



Keyhole
1190.x4.M



Cyl/cyl
1190.x2.E



Blind
1190.x5

no 1190.02.ES



Security escutcheon for outside cylinder, 50x32xH mm.
Heights (H) available: **8, 10, 12, 14, 16** mm.

Solid escutcheon for inside cylinder, 65x30x3 mm.
Fixing centres 20 mm, supplied in pairs incl. M4 machine screws.

ex. how to order: 1190.02.ES.**10**.

Available in satin stainless steel (AISI 304).

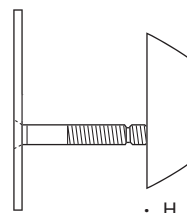

no 1190.02.KS



Security escutcheon for outside cylinder, 50x32xH mm.
Heights (H) available: **10, 12, 14** mm.

Solid escutcheon for inside cylinder, 65x30x3 mm.
Fixing centres 20 mm, supplied in pairs incl. M4 machine screws.

ex. how to order: 1190.02.KS. **10**.

Available in satin stainless steel (AISI 304).

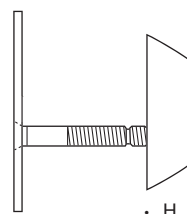

no 1194



Oval escutcheons, for narrow profile doors, 65x30x4 mm.

Rose for lever handle can be fixed to $\varnothing 16$ mm and $\varnothing 19$ mm lever handles.

Available in satin stainless steel (AISI 304).

Drilled for wood screws, fixing centres 49 mm, no visible screws.

Supplied in pairs including wood screws 4x16 mm and machine screws M4x16 mm.

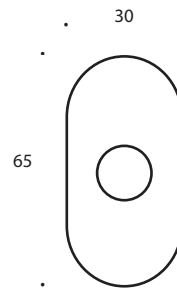

Product variants:



Latch
1194.00



Cyl/turn
1194.01.A



Cyl/cyl
1194.02.A



Cyl/cyl
1194.02.E



Cyl/cyl
1194.02.K



Keyhole
1194.04.M



Keyhole
1194.04.B



Blind
1194.05

no 1194.02.ES



Security escutcheon for outside cylinder, 50x32xH mm, no visible screws. Heights (H) available: **8, 10, 12, 14, 16** mm.

Escutcheon for inside cylinder, 65x30x4 mm. Fixing centres 20 mm.

Supplied in pairs with M4 machine screws.

ex. how to order: 1194.02.ES.10.

Available in satin stainless steel (AISI 304).

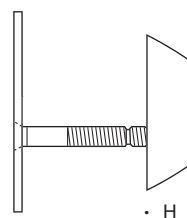

no 1110

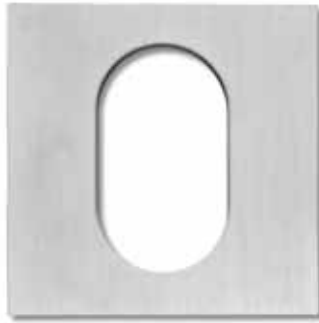

„Square“ escutcheons, 50x50x2 mm.
Designed by Friis & Moltke Design to match the
Square lever handle, no 1075.

Available in satin stainless steel (AISI 304).

With threaded bushes attached, fixing centres 30 mm,
screws visible on one side.

Supplied in pairs including machine screws M4x84 mm.
Bathroom escutcheons: Standard for door thickness 34-50 mm.

Fits Scandinavian standard locks.

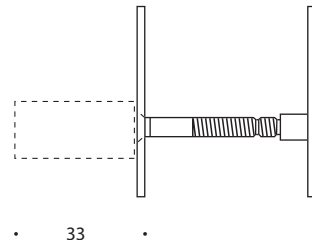

Product variants:



Cyl/turn
1110.012.A



Cyl/cyl
1110.02.A



Bathroom
1110.032.TA/TG



Keyhole
1110.04.F



Blind
1110.05

no 1125

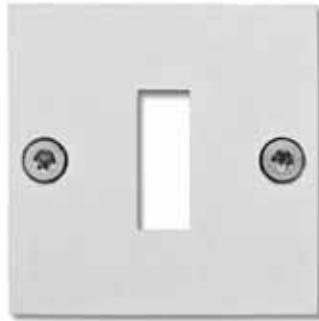

„Square“ escutcheons, 50x50x2 mm.
Designed by Friis & Moltke Design to match the
Square lever handle, no 1075.

Available in satin stainless steel (AISI 304).

Drilled for wood screws, fixing centres 38 mm.

Supplied in pairs including wood screws 3,5x13 mm.
Bathroom escutcheons: Standard for door thickness 34-50 mm.

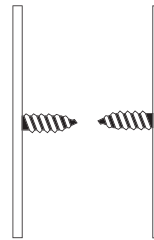

Product variants:



Cyl/cyl
1125.02.E



Bathroom
1125.032.TG



Keyhole
1125.04.M



Blind
1125.05

no 1126



„Square“ escutcheons, 50x50x2 mm.
Designed by Friis & Moltke Design to match the
Square lever handle, no 1075.

Available in satin stainless steel (AISI 304).

With threaded bushes attached, fixing centres 38 mm,
screws visible on one side.

Supplied in pairs including machine screws M4x84 mm and
Randi-Plug®.

Bathroom escutcheons: Standard for door thickness 34-50 mm.

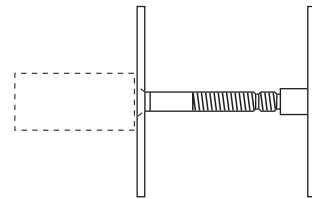

• 33 •

Product variants:



Cyl/cyl
1126.02.E



Bathroom
1126.032.TG



Keyhole
1126.04.F



Blind
1126.05

no 1112



Rectangular rose, 50x150x2 mm.
Designed by Friis & Moltke Designed to match the
Square lever handle no 1075.

Specify right: R or left: L when ordering.

Available in satin stainless steel (AISI 304).

With threaded bushes attached, fixing centres 30 mm,
screws visible on one side.

Supplied in pairs including machine screws M4x84 mm.

Fits Scandinavian standard locks.

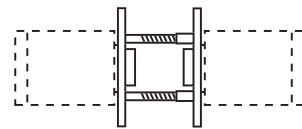

Product variants:



Latch
1112.00.L



Latch
1112.00.R

no 1127



Rectangular rose, 50x150x2 mm.
Designed by Friis & Moltke Design to match the
Square lever handle no 1075.

Available in satin stainless steel (AISI 304).

Drilled for wood screws, fixing centres 38 mm.

Supplied in pairs including wood screws 3,5x13 mm.

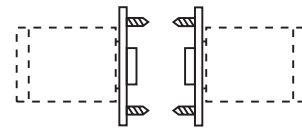

Stainless steel: 1127.00

no 1128



Rectangular rose, 50x150x2 mm.
Designed by Friis & Moltke Design to match the
Square lever handle no 1075.

Available in satin stainless steel (AISI 304).

With threaded bushes attached, fixing centres 38 mm,
screws visible on one side.

Supplied in pairs including machine screws M4x84 mm
and Randi-Plug®.

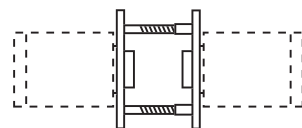

Stainless steel: 1128.00

