

Besætninger

		Side	Model
	Roset Ø50 x 2 mm, massiv c-c 30 mm, gen. skruer	64	1100
	Roset Ø50 x 2 mm, massiv c-c 38 mm, gen. skruer	68	1116
	Roset Ø50 x 2 mm, massiv c-c 38 mm, træskruer.	67	1115
	Roset Ø52 x 4 mm, dækroset, c-c 30 mm, gen. skruer.	70	1140
	Flip-up, ældre- og handicapvenlig løsning	71	1140.038
	Roset Ø52 x 4 mm, dækroset, c-c 38 mm, træskruer	72	1145
	Roset Ø52 x 4 mm, dækroset, c-c 38 mm, gen. skruer.	73	1146
	Koniske cylinderringe:		
	Til ASSA-cylinder indvendig	65	1100.x8.Axi
	Til ASSA-cylinder udvendig	65	1100.x8.Axu
	Til Rokoko-cylinder indvendig	66	1100.08.ARx
	Roset 65 x 30 x 3 mm, massiv c-c 49 mm.	74-75	1190
	Roset 65 x 30 x 4 mm, dækroset, c-c 49 mm	76-77	1194
	Nøddgangsbeslag, Ø55 mm, indvendig Ø50 mm.	66	1109
Besætning til Randi-Line® Square, design Friis & Moltke			
	Roset, 50 x 50 x 2 mm, c-c 30 mm, gen. skruer	78	1110
	Roset, 50 x 50 x 2 mm, c-c 38 mm, gen. skruer	80	1126
	Roset, 50 x 50 x 2 mm, c-c 38 mm, træskruer	79	1125
	Grebsroset, rektangulær, 50 x 150 x 2 mm, c-c 30 mm, gen. skruer	81	1112
	Grebsroset, rektangulær, 50 x 150 x 2 mm, c-c 38 mm, træskruer.	82	1127
	Grebsroset, rektangulær, 50 x 150 x 2 mm, c-c 38 mm, gen. skruer	82	1128

no 1100



Massiv roset, $\varnothing 50 \times 2$ mm.

Leveres som standard i matbørstet rustfrit stål (AISI 304) eller poleret messing.

Med påsvejste gevindstuds, centerafstand 30 mm, synlige skruer på én side.

Leveres i sæt inkl. M4x84 mm skruer.

Toiletbesætning standard for dørtykkelse 34-50 mm.

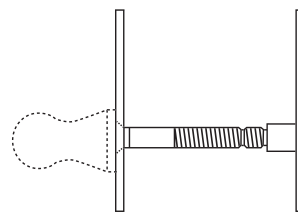

• 25 •

Produktvarianter:



Cyl/Vrid
1100.x1.A



Cyl/Vrid
1100.x1.Ax



Cyl/Vrid
1100.014.A



Vrid
1100.x1.AM4



Cyl/Cyl
1100.x2.A



Cyl/Cyl
1100.x2.Ax



Toilet
1100.x3.TA/TG



Toilet
1100.034.TA/TG



Toilet
1100.x36.TA/TG
1100.x36.TA/TG-SK (til skydedørslås)



Nøglehul
1100.x4.M



Blind
1100.x5



Cyl/Vrid
1100.x16.A

Rustfrit stål: x = 0 Messing: x = 9

Cyl/vridersæt med konisk cylinderring fås i forskellige højder. Rustfrit stål: 7, 11, 13, 16, 18, 20 mm. Messing: 6, 8, 11, 13, 16, 18, 21 mm.

no 1100.x8



Konisk cylinderring, indvendig eller udvendig, $\varnothing 53$ mm.

Leveres som standard i rustfrit stål eller poleret messing, i forskellige højder.

Huller for M4 skruer, centerafstand 30 mm, leveres i stk.

Indvendig ring leveres inkl. M4x84 mm skruer.

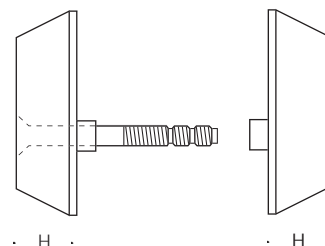

Rustfrit stål højde mm (H)	Indvendig	Udvendig
7	1100.08.A7.i	1100.08.A7.u
11	1100.08.A11.i	1100.08.A11.u
13	1100.08.A13.i	1100.08.A13.u
16	1100.08.A16.i	1100.08.A16.u
18	1100.08.A18.i	1100.08.A18.u
20	1100.08.A20.i	1100.08.A20.u

Poleret messing højde mm (H)	Indvendig	Udvendig
6	p1100.98.A6.i	p1100.98.A6.u
8	p1100.98.A8.i	p1100.98.A8.u
11	p1100.98.A11.i	p1100.98.A11.u
13	p1100.98.A13.i	p1100.98.A13.u
16	p1100.98.A16.i	p1100.98.A16.u
18	p1100.98.A18.i	p1100.98.A18.u
21	p1100.98.A21.i	p1100.98.A21.u

no 1100.08.AR.x



Indvendig, konisk cylinderring for Rokoko cylinder, $\varnothing 53$ mm.

Leveres som standard i matbørstet rustfrit stål (AISI 304).

Huller for M4 skruer, centerafstand 30 mm.

Leveres i stk. inkl. M4x84 mm skruer.

Rustfrit stål højde mm (H)	Indvendig
7	1100.08.AR.7
11	1100.08.AR.11
13	1100.08.AR.13
16	1100.08.AR.16
18	1100.08.AR.18
20	1100.08.AR.20

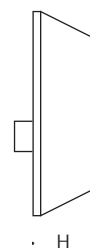

no 1109.00



Nøddgangsbeslag, $\varnothing 55$ mm,
for Randi vrider nr. 1100.01.AM4., side 64.

Rustfri ring, indvendig $\varnothing 50$ mm.

Leveres med løs plastikkop.

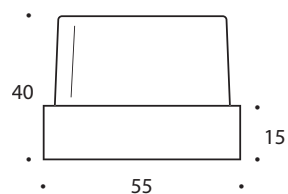

no 1115



Massiv roset, ø50x2 mm.

Leveres som standard i matbørstet rustfrit stål (AISI 304) eller poleret messing.

Huller for træskruer, centerafstand 38 mm.

Leveres i sæt inkl. træskruer 3,5x13 mm.

Toiletbesætning standard for dørtykkelse 34-50 mm.

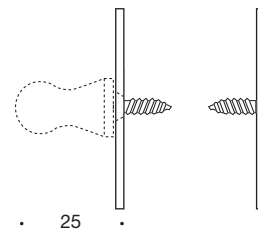

Produktvarianter:



Greb
1115.x0



Cyl/Cyl
1115.x2.R



Nøglehul
1115.x4.B



Cyl/Vrid
1115.x1.R



Toilet
1115.x3.TG/TE



Nøglehul
1115.x4.M



Cyl/Cyl
1115.x2.E



Toilet
1115.034.TG/TE



Blind
1115.x5



Cyl/Cyl
1115.x2.K



Toilet
1115.x36.TG/TE

no 1116



Massiv roset, ø50x2 mm.

Leveres som standard i matbørstet rustfrit stål (AISI 304) eller poleret messing.

Med påsvejste gevindstudse, centerafstand 38 mm, synlige skruer på én side.

Leveres i sæt inkl. M4x84 mm skruer og Randi-Plug®. Toiletbesætning standard for dørtykkelse 34-50 mm.

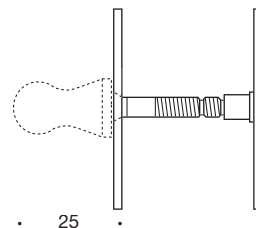

Produktvarianter:



Greb
1116.x0



Toilet
1116.034.TG



Blind
1116.x5



Cyl/Cyl
1116.x2.E



Cyl/Cyl
1116.02.ES



Toilet
1116.x36.TG



Cyl/Cyl
1116.x2.K



Nøglehul
1116.x4.B



Toilet
1116.x3.TG



Nøglehul
1116.x4.M

Rustfrit stål: x = 0 Messing: x = 9

1116.02.ES fås med konisk, rustfri cylinderring i følgende højder: 8, 10, 12, 14, 16 mm. Bestillingseks.: 1116.02.ES10



no 1140



Roset, $\varnothing 52 \times 4$ mm, med underskilt.
Til brug, hvor der ikke ønskes synlige skruer.

Leveres som standard i matbørstet rustfrit stål (AISI 304)
eller poleret messing.

Med løse bøsninger, centerafstand 30 mm, ingen synlige skruer.

Leveres i sæt inkl. M4x84 mm skruer.

Toiletbesætning standard for dørtykkelse 34-45 mm.

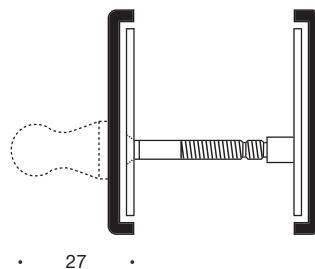

Produktvarianter:



Greb
1140.x0



Cyl/Vrid
1140.x1.A



Vrid
1140.x1.AM4



Cyl/Vrid
1140.014.A



Cyl/Vrid
1140.x16.A



Cyl/Cyl
1140.x2.A



Toilet
1140.x3.TA/TG



Toilet
1140.034.TA/TG



Toilet
1140.x36.TA/TG
1140.x36.TA/TG-SK (til skydedørslås)



Nøglehul
1140.x4.M



Blind
1140.x5

Rustfrit stål: x = 0 Messing: x = 9

Cyl/vridersæt med konisk cylinderring fås i forskellige højder. Rustfrit stål: 7, 11, 13, 16, 18, 20 mm. Messing: 6, 8, 11, 13, 16, 18, 21 mm.

no 1140.038

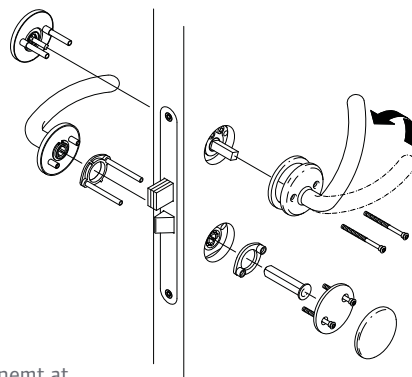

Flip-up grebet er en handicap- og ældrevenlig specialløsning, som gør det nemt at betjene døren og låse op og i, alene ved at løfte grebet eller trykke det ned. Det betyder, at brugeren, modsat mange andre låsesystemer til især toiletter, er fri for den vridende bevægelse, som ofte volder besvær for netop ældre og handicappede.

Den enkle anvendelse gør flip-up grebet til en ideel løsning i alle former for byggeri, hvor handicap- og ældrevenlighed tillægges betydning, herunder sygehuse, plejehjem, ældreboliger etc.

Leveres som standard i matbørstet rustfrit stål (AISI 304).

Leveres med indvendig specialvrider, udvendigt dørgreb (model 1011, 1021, 1060, eller 1090) samt tilhørende besætning $\varnothing 52 \times 4$ mm., M4 skruer og Randi-plug. Centerafstand 30 mm. Standard dørtykkelse 40 mm.

Produktvarianter:



Model 1011
11.40.038/1011



Model 1060
11.40.038/1060



Model 1021
11.40.038/1021



Model 1090
11.40.038/1090

no 1145



Roset, $\varnothing 52 \times 4$ mm, med underskilt.
Til brug, hvor der ikke ønskes synlige skruer.

Leveres som standard i matbørstet rustfrit stål (AISI 304)
eller poleret messing.

Huller for træskruer, centerafstand 38 mm, ingen synlige skruer.

Leveres i sæt inkl. træskruer 3,5x13 mm.

Toiletbesætning standard for dørtrykkelse 34-45 mm.

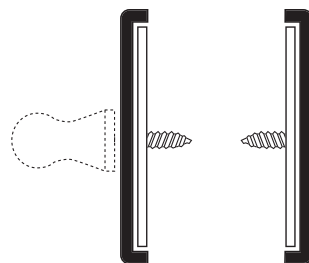

• 27 •

Produktvarianter:



Greb
1145.x0



Cyl/Cyl
1145.x2.E



Cyl/Cyl
1145.x2.K



Toilet
1145.x3.TG



Toilet
1145.034.TG



Toilet
1145.x36.TG



Nøglehul
1145.x4.B



Nøglehul
1145.x4.M



Blind
1145.x5

Rustfrit stål: x = 0 Messing: x = 9

no 1146



Roset, $\varnothing 52 \times 4$ mm, med underskilt.
Til brug, hvor der ikke ønskes synlige skruer.

Leveres som standard i matbørstet rustfrit stål (AISI 304) eller poleret messing.

Med løse bøsninger, centerafstand 38 mm, ingen synlige skruer.

Leveres i sæt inkl. M4x84 mm skruer og Randi-Plug®.

Toiletbesætning standard for dørtykkelse 34-45 mm.

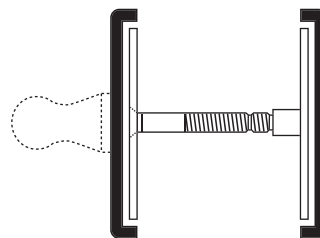

• 27 •

Produktvarianter:



Greb
1146.x0



Toilet
1146.034.TG



Blind
1146.x5



Cyl/Cyl
1146.x2.E



Cyl/Cyl
1146.02.ES



Toilet
1146.x36.TG



Cyl/Cyl
1146.x2.K



Nøglehul
1146.x4.B



Toilet
1146.x3.TG



Nøglehul
1146.x4.M

Rustfrit stål: x = 0 Messing: x = 9

1146.02.ES fås med konisk, rustfri cylinderring i følgende højder: 8, 10, 12, 14, 16 mm. Bestillingseks.: 1146.02.ES10

no 1190



Oval roset, 65x30x3 mm, til smalprofilbøddre.

Leveres som standard i matbørstet rustfrit stål (AISI 304) eller poleret messing.

Huller for skruer, centerafstand 49 mm.

Leveres i sæt inkl. træskruer 4x16 mm samt maskinskruer M4x16 mm.

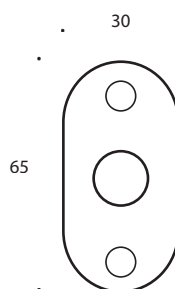

Produktvarianter:



Greb
1190.x0



Cyl/Cyl
1190.x2.K



Cyl/Vrid
1190.x1.A



Nøglehul
1190.x4.B



Cyl/Cyl
1190.x2.A



Nøglehul
1190.x4.M



Cyl/Cyl
1190.x2.E



Blind
1190.x5

no 1190.02.ES



Sikkerhedsroset, 50x32xH mm, til profilylinder. H = højde: **8, 10, 12, 14** eller **16** mm. Centerafstand 20 mm. Til udvendig side.
Roset 65x30x3 mm, til indvendig side. Centerafstand 20 mm.

Leveres som standard i matbørstet rustfrit stål (AISI 304).

Leveres i sæt inkl. patentskruer M4x84 mm.

Bestillingseks.: 1190.02.ES.10

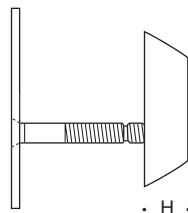

no 1190.02.KS



Sikkerhedsroset, 50x32xH mm, til Keso cylinder. H = højde: **10, 12** eller **14** mm. Centerafstand 20 mm. Til udvendig side.
Roset 65x30x3 mm, til indvendig side. Centerafstand 20 mm.

Leveres som standard i matbørstet rustfrit stål (AISI 304).

Leveres i sæt inkl. patentskruer M4x84 mm.

Bestillingseks.: 1190.02.KS.10

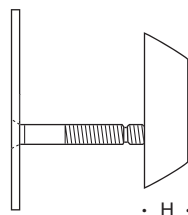

no 1194



Oval roset med underskilt til smalprofildøre, 65x30x4 mm.
Til brug, hvor der ikke ønskes synlige skruer.

Leveres som standard i matbørstet rustfrit stål (AISI 304).

Grebsrosetten kan anvendes på $\varnothing 16$ mm og $\varnothing 19$ mm dørgreb.

Huller for skruer, centerafstand 49 mm, ingen synlige skruer.

Leveres i sæt inkl. træskrue 4x16 mm samt maskinskrue M4x16 mm.

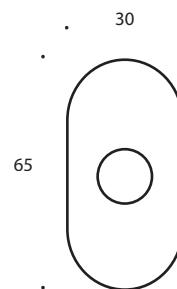

Produktvarianter:



Greb
1194.00



Cyl/Vrid
1194.01.A



Cyl/Cyl
1194.02.A



Cyl/Cyl
1194.02.E



Cyl/Cyl
1194.02.K



Nøglehul
1194.04.M



Nøglehul
1194.04.B



Blind
1194.05

no 1194.02.ES



Sikkerhedsroset, 50x32xH mm, til profilcylinder. H = højde: 8, 10, 12, 14 eller 16 mm. Centerafstand 20 mm, ingen synlige skruer. Til udvendig side.
Roset 65x30x4 mm, til indvendig side. Centerafstand 20 mm.

Leveres som standard i matbørstet rustfrit stål (AISI 304).

Leveres i sæt inkl. patentskruer M4x84 mm.

Bestillingseks.: 1194.02.ES.10

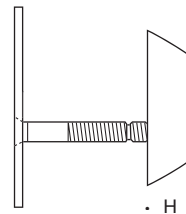

no 1110



Kvadratisk roset, 50x50x2 mm.
En del af Square-serien, designet af Friis & Moltke Design.

Leveres som standard i matbørstet rustfrit stål (AISI 304).

Med påsvejste gevindstudse, centerafstand 30 mm,
synlige skruer på én side.

Leveres i sæt inkl. M4x84 mm skruer.
Toiletbesætning standard for dørtykkelse 34-50 mm.

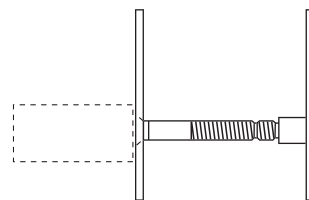

• 33 •

Produktvarianter:



Cyl/Vrid
1110.012.A

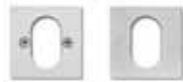

Cyl/Cyl
1110.02.A



Toilet
1110.032.TA/TG



Nøglehul
1110.04.F



Blind
1110.05

no 1125



Kvadratisk roset, 50x50x2 mm.
En del af Square-serien, designet af Friis & Moltke Design.

Leveres som standard i matbørstet rustfrit stål (AISI 304).

Huller for træskruer, centerafstand 38 mm.

Leveres i sæt inkl. træskruer 3,5x13 mm.
Toiletbesætning standard for dørtykkelse 34-50 mm.

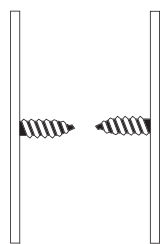

Produktvarianter:



Cyl/Cyl
1125.02.E



Toilet
1125.032.TG

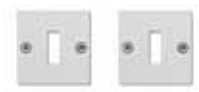

Nøglehul
1125.04.M



Blind
1125.05

no 1126



Kvadratisk roset, 50x50x2 mm.
En del af Square-serien, designet af Friis & Moltke Design.

Leveres som standard i matbørstet rustfrit stål (AISI 304).

Med påsvejste gevindstudse, centerafstand 38 mm,
synlige skruer på én side.

Leveres i sæt inkl. M4x84 mm skruer og Randi-Plug®.
Toiletbesætning standard for dørtykkelse 34-50 mm.

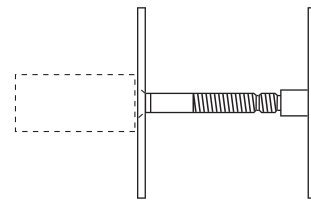

• 33 •

Produktvarianter:



Cyl/Cyl
1126.02.E



Toilet
1126.032.TG



Nøglehul
1126.04.F



Blind
1126.05

no 1112



Rektangulær roset, 50x150x2 mm.
 En del af Square-serien, designet af Friis & Moltke Design.
 Husk at angive højre: R eller venstre: L ved bestilling.

Leveres som standard i matbørstet rustfrit stål (AISI 304).

Med påsvejste gevindstudse, centerafstand 30 mm,
 synlige skruer på én side.

Leveres i sæt inkl. M4x84 mm skruer.

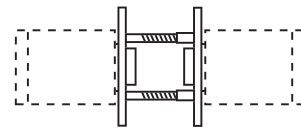

Produktvarianter:



Greb
1112.00.L



Greb
1112.00.R

no 1127



Rektangulær roset, 50x150x2 mm.
En del af Square-serien, designet af Friis & Moltke Design.

Leveres som standard i matbørstet rustfrit stål (AISI 304).

Huller for træskruer, centerafstand 38 mm.
Leveres i sæt inkl. træskruer 3,5x13 mm.

Leveres i sæt inkl. M4x84 mm skruer og Randi-Plug®.

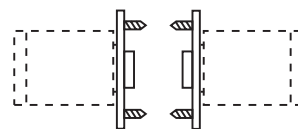

Rustfrit stål: 1127.00

no 1128



Rektangulær roset, 50x150x2 mm.
En del af Square-serien, designet af Friis & Moltke Design.

Leveres som standard i matbørstet rustfrit stål (AISI 304).

Med påsvejste gevindstudse, centerafstand 38 mm,
synlige skruer på én side.

Leveres i sæt inkl. M4x84 mm skruer og Randi-Plug®.

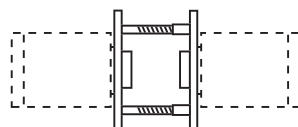

Rustfrit stål: 1128.00





Statsfængslet i Østjylland, Horsens.
Arkitekter: Friis & Moltke A/S